



Vinoferm® Fruit Press wooden basket 12 l + 18 l

015.080.12 + 015.080.18
Instruction manual

EN Vinoferm® Fruit Press wooden basket 12 l + 18 l

015.080.12 + 015.080.18

Thank you for purchasing the Vinoferm® Fruit press.

PARTS LIST:

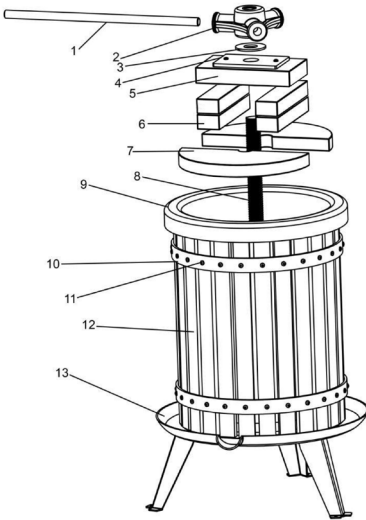

Part No.	Description	QTY
1	Handle	1
2	Trunnion	1
3	Nylon washer	1
4	Metal pressing plate	1
5	Wooden pressing plate	1
6	Wooden blocks	4
7	Wooden plate	2
8	Threaded rod	1
9	Juice bag	1
10	Metal ring	2
11	Screw	See remark
12	Cage slat	See remark
13	Base	1

Remark:

Model	Part 11	Part 12
12 l	53 pcs	25 pcs
18 l	53 pcs	25 pcs

Additional parts that may be needed but are not included: screws to mount feet of base to solid base.

USAGE:

- The Vinoferm® Fruit Press needs to be assembled. You can find the assembly instructions further on.
- Clean the Vinoferm® Fruit Press before and after each use with Chemipro® Wash and Chemipro® San. Then dry thoroughly.
- If left unused for prolonged periods, coat all metal components with a thin film of Vaseline or food-safe oil and store in a clean, dry environment. Check the press's condition before using again and if mold is apparent, wash thoroughly, rinse, dry and apply a film of fresh food-safe oil to its metal components.
- Before use, all components must be scrupulously clean and all traces of old oil removed to avoid the possibility of contamination of the produce.
- To maximise the yield from your fruit, it is best to grind or crush the fruit prior to pressing. You can run the fruit through your fruit crusher, shredder or food mill to reduce the size.
- Ensure that the legs of the Vinoferm® Fruit Press are attached and screwed to a flat surface prior to pressing. This will prevent the unit from sliding or tipping over during operation.
- Keep hands clear while the press is turning.
- Do not alter the handle by making it longer.
- There is a 2-year warranty on this Vinoferm® Fruit press.

ASSEMBLY AND OPERATION:

1. Wooden barrel assembly--- Assemble metal ring (10) and cage slat (12), make sure all cage slats (12) with bevel edge are in one direction, the opposite end with smooth edge in line in the opposite side.

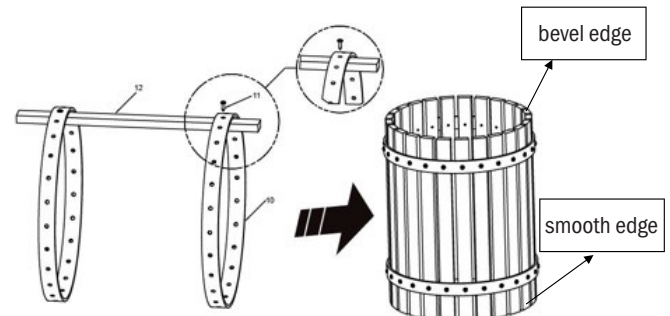

2. Wooden pressing plate (5) and metal pressing plate (4) assembly with screws (11).

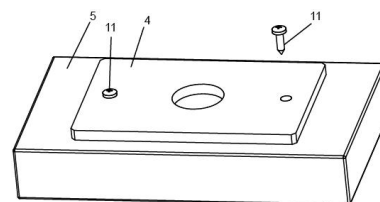

3. Threaded rod assembly (8), then mount to the base (13). NOTE: The threaded rod with the 2 small pieces, should be assembled first.

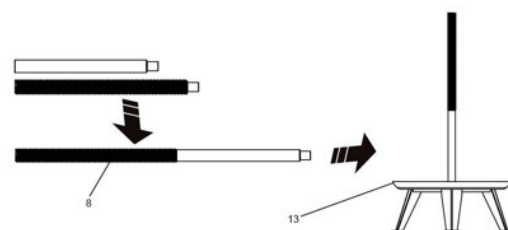

4. The base of the press should be screwed to the floor or to a firm, solid base, using the holes in the feet (screws not included).

Attention:
 smooth edge must
 contact the base

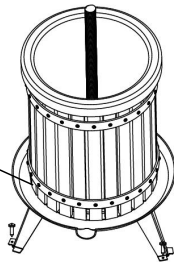

5. Put the empty juice bag (9) in the press with the threaded rod (8) through the hole in the juice bag. Stretch the juice bag over the bucket. Then fill it with the chopped fruit and, if necessary press down the fruit by hand. When the juice bag is filled, fold it inwards.

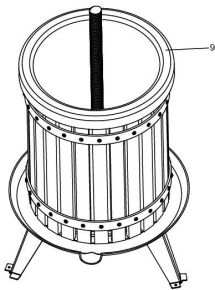

6. Place the 2 wooden semi-discs (7) on top of the fruit, followed by the wooden blocks (6). Subsequently place the pressing plate assembly (4 & 5) on top of them, so it is crossing lengthwise over the wooden plates.

Put chopped fruits inside the bucket

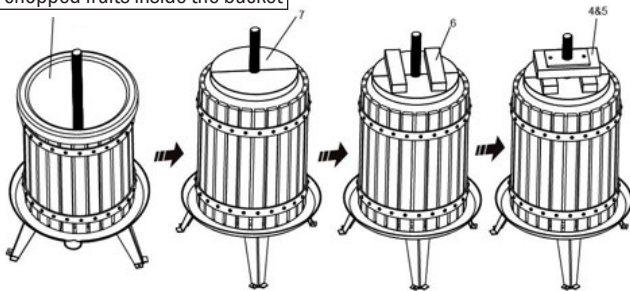

7. Place the nylon washer (3) on top of the pressure plate assembly as shown in the illustration. Screw on the trunnion (2), push the handle (1) into the trunnion and rotate the handle (1) down to press the fruit down into the barrel.

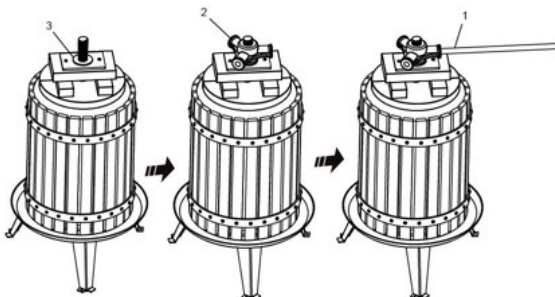

8. Never use an extension bar on the handle. The second pair of blocks provided may be inserted when space allows for it, to force the wooden plates as near as possible to the base of the press. If the handle reaches the wooden barrel assembly and pressure still needs to be increased, release the trunnion and place one set of wooden blocks between the wooden plates and the pressing plates. Place a container beneath the outlet spout in the base (13) to collect the juice.

DISASSEMBLY:

- Disassemble unit by removing handle from the trunnion.
- Unscrew the trunnion from the threaded bar.
- Remove all wooden blocks and pressing plates.
- Barrel can now be lifted from the base.
- Unscrew the feet of the base.

